

Grand Bundle PDF Course 2021

Exams Covered:

**SBI Clerk | SBI PO | IBPS RRB PO |
IBPS RRB Clerk | IBPS PO | IBPS Clerk**

Separate PDF Course for All Major Bank pre + Mains Exams

- Total No. of Ques: **40,000+**
- Question in Bilingual (Eng & Hindi)
- Answers With Detailed **Video Solution**
- Provides you **50 days Study Planner** for each exams
- **Covers All Types** of Questions in Each Topic
- Questions in **Exact Exam Level**
- All Our PDFs are **Downloadable**
- **100% Satisfaction** Assured & It's Worthy for your money
- Download as PDF & also take **Quiz with Timer**



Grab It Now

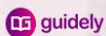

Grand Bundle PDF Course for All Bank Prelims Exams 2021

Separate PDF Courses for All Major Bank Exams

- Total Number of Questions: **25000**
- Language: English & Hindi
- Exact Exam Level Questions
- Answer Key with Video Solution

Exams Covered:

- SBI Clerk
- SBI PO
- IBPS PO
- IBPS Clerk
- IBPS RRB PO
- IBPS RRB Clerk

Validity: **1 Year**

Grab It Now



Grand Bundle PDF Course for All Bank Mains Exams 2021

Separate PDF Courses for All Major Bank Exams

- Total Number of Questions: **15000**
- Language: English & Hindi
- Exact Exam Level Questions
- Answer Key with Video Solution

Exams Covered:

- SBI Clerk
- SBI PO
- IBPS PO
- IBPS Clerk
- IBPS RRB PO
- IBPS RRB Clerk

Validity: **1 Year**

Grab it Now



Grand Bundle PDF Course Combo Prelims + Mains 2021

Separate PDF Courses for All Major Bank Exams

- Total Number of Questions: **40000+**
- Language: **English & Hindi**
- **Exact Exam Level** Questions
- Answer Key with **Video Solution**

Exams Covered:

- SBI Clerk
- SBI PO
- IBPS PO
- IBPS Clerk
- IBPS RRB PO
- IBPS RRB Clerk

Validity: **1 Year**

Grab it Now

Top Important Seating Arrangement Questions for IBPS PO Pre 2021 – English Version

Directions (1-5): Study the following information carefully and answer the below questions

Twelve persons are sitting on two parallel rows and facing each other. In Row1 A, B, C, D, E, and F are seated facing south. In row2 P, Q, R, S, T, and U are seated and faces north.

Two persons are sitting between S and R who sits at the end of the row. The one who faces S is sitting second to the left of B. The number of persons sitting to the left of B is the same as to the right of C. E sits immediate left of the one who faces P. E sits adjacent to C. Q sits third to the left of U. The number of persons sitting between Q and P is the same as between F and C. At least two persons are sitting to the left of F. A sits adjacent to neither C nor B.

1) Who among the following person sits opposite to each other?

- I. DQ
- II. EU
- III. BT
- A. Only II
- B. Only I and III
- C. Only III
- D. All I, II and III
- E. None of these

2) Four of the five among the following are similar in such a way to form a group, who among the following doesn't belong to the group?

- A. TS
- B. PR
- C. FC
- D. BA

E. QU

3) Who among the following person sits second to the left of P?

- A. The one who sits immediate left of S
- B. The one who sits immediate right of U
- C. B
- D. The one who sits opposite to E
- E. T

4) Which of the following statement is/are True?

- I. Only one person sits between T and S
- II. F sits immediate left of A
- III. B and R are diagonally opposite to each other.
- A. Only I and III
- B. Only III
- C. Only I and II
- D. Only II
- E. All are true

5) How many persons are sitting between E and B?

- A. Three
- B. Two
- C. One
- D. No one
- E. More than three

Directions (6-10): Study the following information carefully and answer the questions given below.

Six countries viz. O, P, Q, R, S, and T are in a straight line such that their directions are mentioned with respect to north, but not necessarily in the same order. Each country has

Top Important Seating Arrangement Questions for IBPS PO Pre 2021 – English Version

different climatic conditions viz. Autumn, Monsoon, Rainy, Spring, Summer, and Winter.

The country which has a rainy climate is fourth to the right of T. Only two countries are there between T and the country which has a winter climate. The country which has the monsoon climate is third from one of the ends of the row. Only one country is there between the country which has monsoon climate and O, which is not adjacent to T. Q is to the immediate left of O. The number of countries to the right of Q is one more than the number of countries to the left of the country which has spring climate. S is to the immediate right of the country which has a spring climate. R is neither adjacent to T nor has a rainy climate. The country which has an autumn climate is not adjacent to P.

6) What is the position of the country P with respect to the country which has Monsoon?

- A. Second to the right
- B. Third to the right
- C. Immediate left
- D. Second to the left
- E. None of these

7) Which of the following country has a Rainy season?

- A. P
- B. The Country which is second to the right of Q
- C. The Country which is at the left end
- D. O
- E. None of these

8) How many countries are there between the country which has Summer and S?

- A. As many countries to the right of O
- B. Three
- C. As many countries between P and Q
- D. Two
- E. Both A and C

9) If S is related to the Rainy season, similarly Q is related to the Autumn season, then which among the following country is related to the Monsoon season?

- A. T
- B. The country which is second to the left of Q
- C. O
- D. The country which is at the right end
- E. None of these

10) Four of the five are related to each other in a certain way, find the odd one out?

- A. R – Rainy
- B. P – Winter
- C. O – Monsoon
- D. Q – Autumn
- E. R – Winter

Directions (11-15): Study the following information carefully and answer the below questions.

Eight persons are sitting around the square table. Four persons are sitting at the corner faces inside the table and four persons are sitting at the middle faces outside the table.

Top Important Seating Arrangement Questions for IBPS PO Pre 2021 – English Version

B sits second to the right of D, who doesn't face away from any person. E sits three places away from D and does not sit two places away from A. Two persons sit between H and G. A sits second to the right of G. F sits two places away from the person who faces H. The number of persons sits between A and C is one more than the number of persons sits between F and G when counted from the left of both A and G.

11) Who sits fourth to the right of C?

- A. Person who sits opposite to E
- B. Person who sits opposite to A
- C. Person who sits opposite to F
- D. Person who sits immediate left of B
- E. None of these

12) Who sits sixth to the left of the person who faces B?

- A. Person who sits third to the right of C
- B. Person who sits second to the left of F
- C. Person who sits opposite to E
- D. Person who sits second to the left of B
- E. None of these

13) Which of the following statement is/are true with respect to H?

- I. Both C and E are the immediate neighbours of H
 - II. B sits second to the left of the person who sits opposite to H
 - III. More than two persons sit between H and the person who faces B in both ways.
- A. Only I
 - B. Both I and II
 - C. Both II and III

- D. All I, II and III
- E. None of these

14) Four of the following five are alike in a certain way and hence form the group. Which is the one that does not belong to the group?

- A. H
- B. B
- C. D
- D. F
- E. G

15) In which of the following statement the first person sits immediate left and immediate right of the second and third persons respectively?

- I. BGE
 - II. FAC
 - III. GBD
- A. Only I
 - B. Only III
 - C. Only I and III
 - D. All I, II and III
 - E. None of these

Directions (16-20): Study the following information carefully and answer the questions given below.

Eight people P, Q, R, S, T, U, V, and W are sitting around a circular table and all are facing towards the centre. All of them are using different mobile brands Oppo, Apple, Vivo, and Sony not more than two persons using the same mobile brands. All the information is not necessarily in the same order.

Top Important Seating Arrangement Questions for IBPS PO Pre 2021 – English Version

The person who uses Vivo is sitting second to the right of W, both of them using the same mobile brand. Two persons sit between W and the person who uses Oppo. Q uses Sony and sits opposite to W. Three persons sit between the persons who are using apple. One of the persons who uses apple has both the immediate neighbors are using Vivo. U sits third to the left of R and using Oppo. V is not facing the person who uses Oppo and Apple. P is using the same mobile brand of Q and not an immediate neighbor of the person using Apple. S is not using Vivo.

16) Who among the following persons using Apple?

- A. T and R
- B. U and V
- C. S and R
- D. P and S
- E. None of these

17) Four of the following five are alike in a certain way and thus form a group as per the given arrangement. Which of the following does not belong to that group?

- A. SR
- B. UV
- C. PQ
- D. WT
- E. RV

18) If all the persons are arranged in alphabetical order starting from P in an

anticlockwise direction, then how many persons remain in the same position including P?

- A. One
- B. Two
- C. Three
- D. Four
- E. No one

19) If R is related to U and P is related to Q, then who among the following is related to T?

- A. The one who sits immediate right of W
- B. U
- C. S
- D. P
- E. The one who sits opposite to Q

20) Which of the following combination is true?

- A. R – Apple
- B. P – Sony
- C. U – Oppo
- D. T – Vivo
- E. All of the above

Directions (21-25): Study the following information carefully and answer the below questions

A certain number of persons are sitting in the linear row facing the north direction. Q sits fifth to the left of I. Only two persons are sitting between I and M. The number of persons sitting between Q and M is two less than the number of persons sitting between M and J. I and J are not immediate neighbors. L sits fourth to the right of J. X sits eighth to the left of Q. T sits exactly in

Top Important Seating Arrangement Questions for IBPS PO Pre 2021 – English Version

the middle of Q and X who sits on one of the ends. The number of persons sits to the left of T is the same as the persons to the right of L. P sits immediate right of V. V sits to the right of J. P neither adjacent to I nor M. More than five persons sit between J and V.

21) How many persons sit between Q and J?

- A. 12
- B. 11
- C. 14
- D. 17
- E. 15

22) Who among the following persons sit between I and V?

- I) M
- II) The one who sits fourth to the left of P
- III) Q
- A. Only (I) and (II)
- B. Only (I)
- C. Only (I) and (III)
- D. Only (III)
- E. All (I), (II), and (III)

23) How many persons sit in the row?

- A. 32
- B. 35
- C. 33
- D. 31
- E. 36

24) What is the position of M from the extreme right end?

- A. Fourteenth
- B. Nineteenth

- C. Thirteenth
- D. Twelfth
- E. Eleventh

25) Who among the following person sits fifth from the left end?

- A. The one who sits sixth to the left of I
- B. Q
- C. T
- D. The one who sits tenth to the left of M
- E. J

Direction (26-30): Study the following information carefully and answer the questions given below.

Study the following information carefully and answer the questions given below:

Eight students i.e. P, Q, R, S, J, K, L, and M of different classes sit in a square table but not necessarily in the same order. Four students sit at a corner and four students sit at the middle of the side of the square. Students sit at a corner face outside and students sit at the middle of the side face towards the center.

(only rearranged based on explanation) There are three students sit between L and class 5 student. Class 5 student sits immediate left of P. Q sits 3rd to the left of L. Class 7 student is an immediate neighbor of Q. Class 6 student sits 2nd to the right of class 7 student. R who is in class 8, sits 3rd to the right of Q. S sits immediate right of J who is in class 9. Students of class 11 and 12 sits opposite to each other. Student of class 10 sits 2nd to the right of class

11 student. K who faces outside is not an immediate neighbor of Q.

26) Who among the following sits immediate left of M?

- A. P
- B. The one who sits third to the left of L
- C. R
- D. The one who sits immediate right of J
- E. None of these

27) L studies in which among the following class?

- A. Class 5
- B. Class 6
- C. Class 7
- D. Class 10
- E. None of these

28) How many students are sitting between P and the student of class 12 when counted clockwise from P?

- A. One
- B. Two
- C. Three
- D. More than three
- E. None

29) Who among the following sits 2nd to the right of the student who sits 3rd to the left of M?

- A. The one who sits immediate left of S
- B. R
- C. The one who sits opposite to L
- D. J
- E. None of these

30) Four of the following five are alike in a certain way based on a group, find the one which does not belong to that group?

- A. R
- B. S
- C. P
- D. M
- E. L

Directions (31-35): Study the following information carefully and answer the below questions.

Eight persons – P, Q, R, S, T, U, V and W are sitting around the circular table. Four of them are facing towards the table and four of them are facing outwards the table.

Three persons sit between V and R. Both R and V are facing the opposite directions to each other. S sits second to the right of R. W faces the one who sits second to the right of V. U sits third to the left of W. Neither R nor S sits an immediate neighbour of Q. T faces the one who sits second to the left of Q. P facing outwards and the immediate neighbours of P facing the opposite direction to P.

31) Who sits fourth to the right of P?

- A. U
- B. W
- C. The person facing W
- D. The one who sits opposite to P
- E. None of these

32) In which of the following statement the third person doesn't sit exactly in the middle of first and second person as per the final arrangement?

I).UPQ

II).TUV

III).VRW

A. Only II

B. Only I and III

C. Only III

D. All I, II and III

E. Other than the given option

33) How many persons sit between Q and the one who faces S when counted from the right of Q?

A. Two

B. Three

C. Four

D. Five

E. Other than the given option

34) Who among the following one sits second to the left of the one who sits fifth to the left of U?

A. theOne who faces R

B. theOne who faces P

C. the One who faces S

D. the One who faces W

E. Other than the given option

35) Four of the following five are alike in a certain way and hence form a group. Which of the following one does not belong to the group?

A. W

B. S

C. V

D. R

E. T

Directions (36-40): Study the following information carefully and answer the below questions

Eight persons- Ajay, Ajit, Deva, Druv, Gaya, Guna, Hari, and Janu are sitting in the linear row. Four of them are facing north and four of them are facing south but not necessarily in the same order. Not more than two persons are facing the same direction sit together.

Ajit sits third to the right of Druv, Vice versa.

Only one person sits between Druv and Deva.

Ajit and Deva are not immediate neighbors. Ajay sits adjacent to Deva and sits at end of the row.

Hari sits second to the right of Ajay, vice versa.

The persons who are sitting at the end are facing the opposite direction. The number of persons sitting between Gaya and Guna is the same as between Deva and Druv. Guna does not face the north direction. Deva is facing the opposite direction of Guna. Immediate neighbors of Hari facing the same direction.

36) Who among the following person sits second to the left of Gaya?

A. The one who sits immediate left of Hari

B. The one who sits second to the left of Deva

C. Ajay

D. The one who sits second to the right of Guna

E. Ajit

Top Important Seating Arrangement Questions for IBPS PO Pre 2021 – English Version

37) Which of the following statement is/are true?

- I. Only one person sits between Hari and Janu
 - II. Ajit and Guna are facing the same direction
 - III. Deva sits adjacent to Guna
- A. Only I and III
 - B. Only I
 - C. Only I and II
 - D. Only II
 - E. None of the statement is false

38) What is the position of Hari with respect to Ajit?

- A. Second to the right
- B. Third to the right
- C. Fourth to the right
- D. Third to the left
- E. Fifth to the right

39) Four of the following are alike in a certain way. Who among the following one does not belong to the group?

- A. Ajay, Deva
- B. Druv, Gaya
- C. Guna, Hari
- D. Ajit, Janu
- E. Ajay, Guna

40) How many persons sit to the right of Janu?

- A. Four
- B. Three
- C. Two
- D. Five
- E. One

Directions (41-45): Answer the questions based on the information given below.

Ten persons viz. A, B, C, D, E, F, G, H, I, and J are sitting in a rectangular table in such a way that three persons each are sitting on the longer side and faces towards the center while two persons each are sitting on the shorter side and faces away from the center, but not necessarily in the same order.

E sits to the immediate left of G and vice versa. H sits third to the right of G and immediate right of D. I sits to the immediate left of the one who is exactly opposite to G and is two persons away from B who is not the immediate neighbor of E. Both J and C sit adjacent to each other but don't face the same direction. A sits three persons away from J. F is neither adjacent to D nor opposite to G.

41) Who among the following person sits to the immediate left of B?

- A. The one who sits immediate right of I.
- B. A
- C. The one who sits second to the left of C.
- D. H
- E. None of these

42) How many persons sit between E and D when counted from the right of E?

- A. 1
- B. 2
- C. 3
- D. 4
- E. More than four

Top Important Seating Arrangement Questions for IBPS PO Pre 2021 – English Version

43) Who among the following person sits exactly opposite to the one who sits to the immediate right of F?

- A. B
- B. The one who sits immediate left of D
- C. D
- D. The one who sits immediate right of J
- E. None of these

44) Four of the following five are alike in a certain way and hence form a group. Find the one who doesn't belong to that group.

- A. G
- B. D
- C. C
- D. H
- E. F

45) Who among the following person sits fourth to the left of G?

- A. I
- B. C
- C. F
- D. The one who sits opposite to A
- E. Both options (a) and (d)

Directions (46-50): Study the following information carefully and answer the below questions.

Twelve mobiles are showcased in the mobile shop on two parallel rows. The mobile- Nokia, Samsung, Realme, Asus, LG, and Moto are showcased facing south opposite to Vivo, Oppo, MI, One plus, Honor, and Apple which are facing

north. The mobiles are different price viz., 8k, 10k, 12k, 15k, 18k, 19k, 20k, 22k, 28k, 35k, 40k, and 46k but not necessarily in the same order.

The price of Samsung is 18k which is placed 3rd to the right of the Asus which price is 8k which is second from the left end. Asus is placed opposite to apple which is placed adjacent to Honor. Only one mobile is placed between Honor & Vivo which is the immediate right of Oppo which is 40k. The price of One plus is 19k diagonally opposite to Nokia which price is 20k. One plus is not adjacent to Honor. Realme placed one of the ends. Two mobiles are between 28k and 46k which is adjacent to 35k. Moto placed opposite to 22k mobile. Realme is 2k less than moto which is 10k less than Mi.

46) Which of the following combination is false?

- A. Vivo-28K
- B. MI-22k
- C. Honor-10k
- D. Apple-46k
- E. Moto-12K

47) Which of the following mobile does not belong to the group?

- A. Price of mobile 20K
- B. Realme
- C. Second to the right of mobile which price is 35K
- D. Oppo
- E. Vivo

48) What is the price of MI mobile?

- A. 12k

Top Important Seating Arrangement Questions for IBPS PO Pre 2021 – English Version

- B. 35k
- C. 10k
- D. 22k
- E. 46k

49) What is the position of Samsung with respect to 15k mobile?

- A. Immediate left
- B. Immediate right
- C. Second to the right
- D. Third to the left

E. Second to the left

50) Which of the following mobile is placed opposite to the one which price is 19k?

- A. Moto
- B. Asus
- C. Samsung
- D. Realme
- E. Nokia

Answer With Explanation

Directions (1-5):

- 1) Answer: D
- 2) Answer: E
- 3) Answer: A
- 4) Answer: E
- 5) Answer: A

Final Arrangement

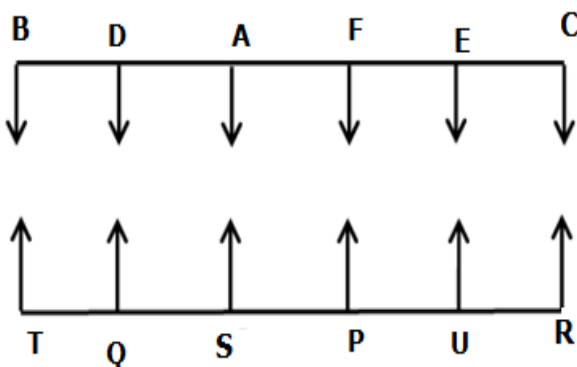

We have,

- Two persons are sitting between S and R who sits at the end of the row.
- The one who faces S is sitting second to the left of B.

From the above condition, there are two possibilities.

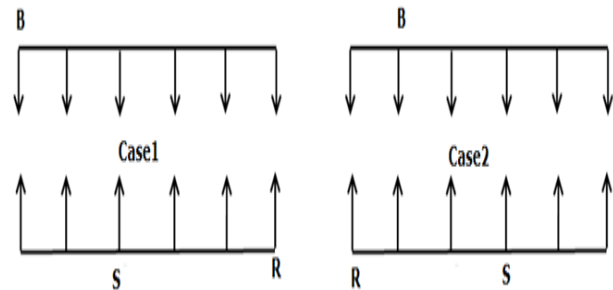

Again we have,

- The number of persons sitting to the left of B is the same as to the right of C.
- E sits immediate left of the one who faces P.
- E sits adjacent to C.

From the above condition, there are three possibilities.

Top Important Seating Arrangement Questions for IBPS PO Pre 2021 – English Version

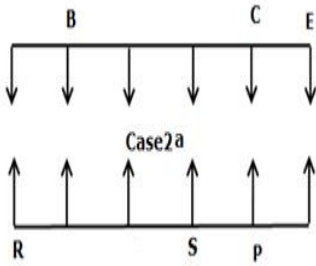
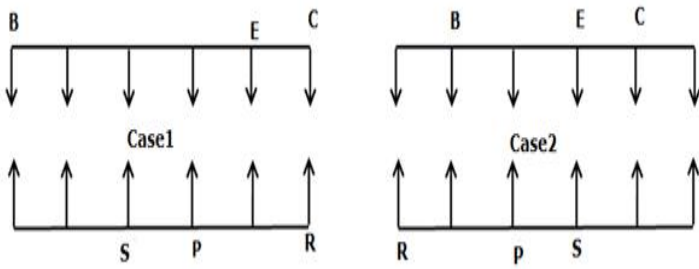

Again we have,

- Q sits third to the left of U.
- The number of persons sitting between Q and P is the same as between F and C.
- At least two persons are seated left of F.

From the above condition, case2 gets eliminated.

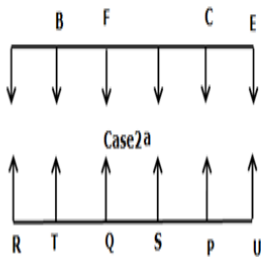
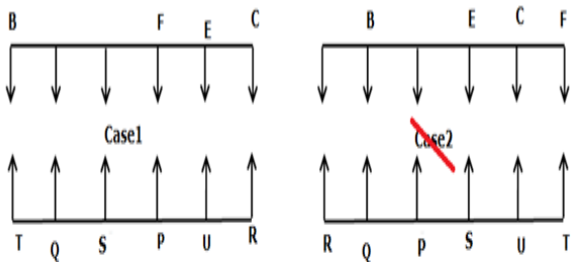

Again we have,

- A sits adjacent to neither C nor B.

From the above condition, case2a get eliminated. case1 shows the final arrangement.

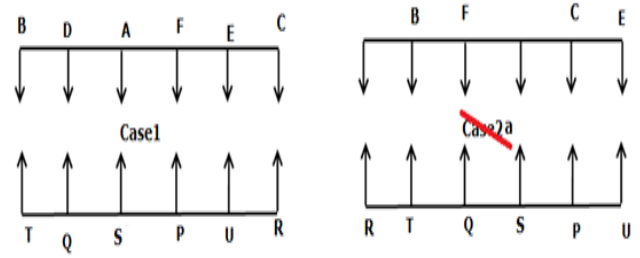

Directions (6-10):

6) Answer: C

7) Answer: D

8) Answer: E

9) Answer: A

10) Answer: A

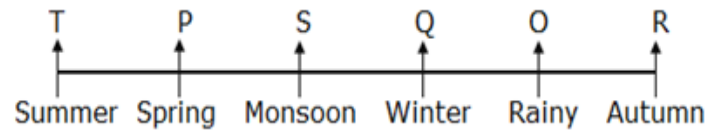

1. The country which has a rainy climate is fourth to the right of T. Only two countries are there between T and the country which has winter climate.

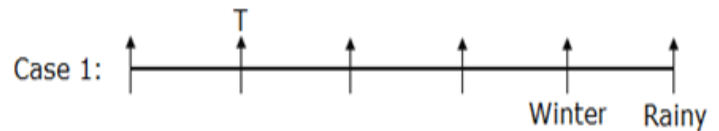

2. The country which has the monsoon climate is third from one of the ends of the row. Only one country is there between the country which has a monsoon climate and O, which is not adjacent to T.

Top Important Seating Arrangement Questions for IBPS PO Pre 2021 – English Version

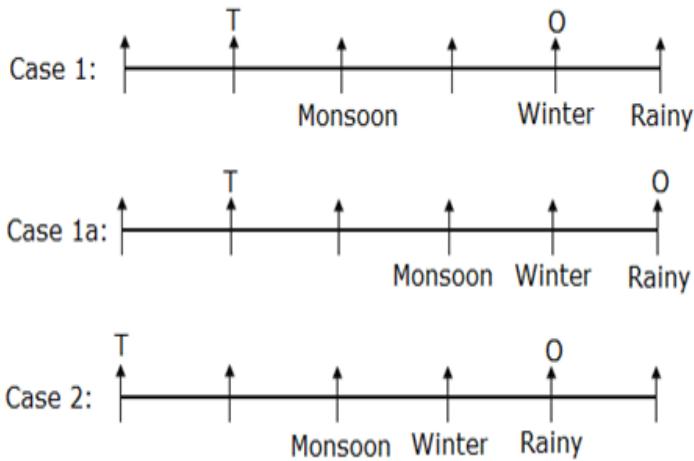

3. Q is to the immediate left of O. The number of countries to the right of Q is one more than the number of countries to the left of the country which has spring climate. S is to the immediate right of the country which has a spring climate. Hence, case 1a gets eliminated.

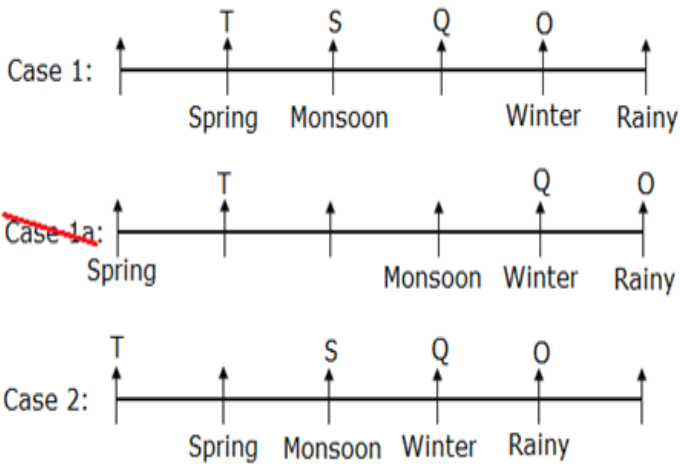

4. R is neither adjacent to T nor has a rainy climate. The country which has an autumn climate is not adjacent to P. Hence, case 1 gets eliminated.

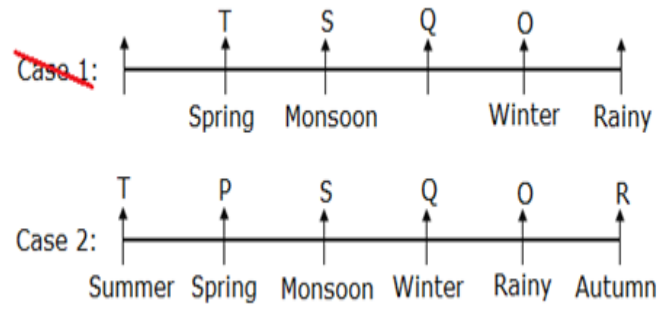

Directions (11-15):

- 11) Answer: D
- 12) Answer: D
- 13) Answer: A
- 14) Answer: E
- 15) Answer: C

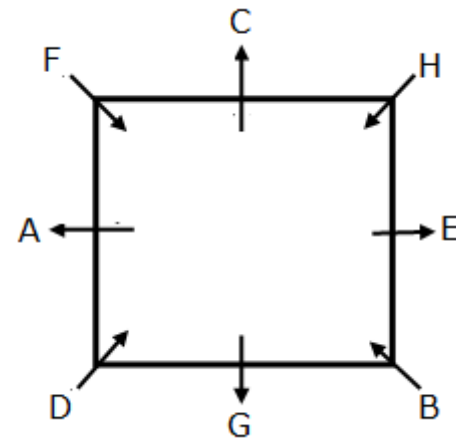

B sits second to the right of D, who doesn't face away from any person. E sits three places away from D.

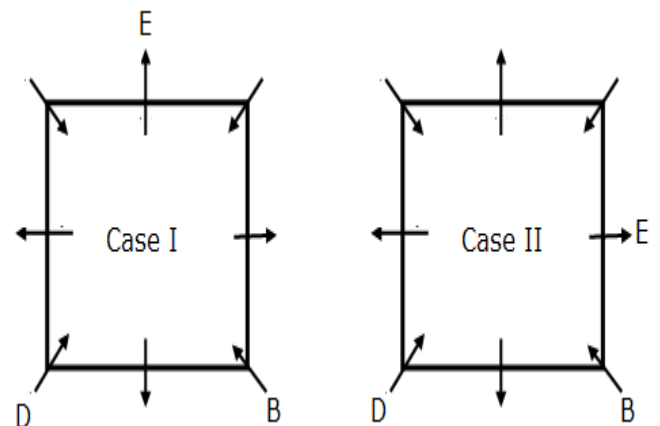

Top Important Seating Arrangement Questions for IBPS PO Pre 2021 – English Version

Two-persons sit between H and G. A sits second to the right of G.

F sits two places away from the person who faces H. E does not sit two places away from A.

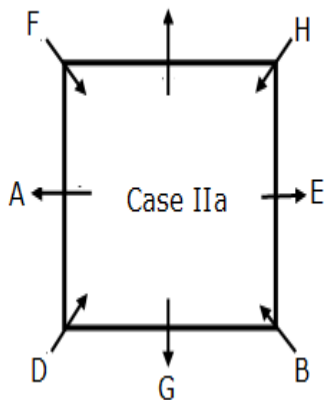
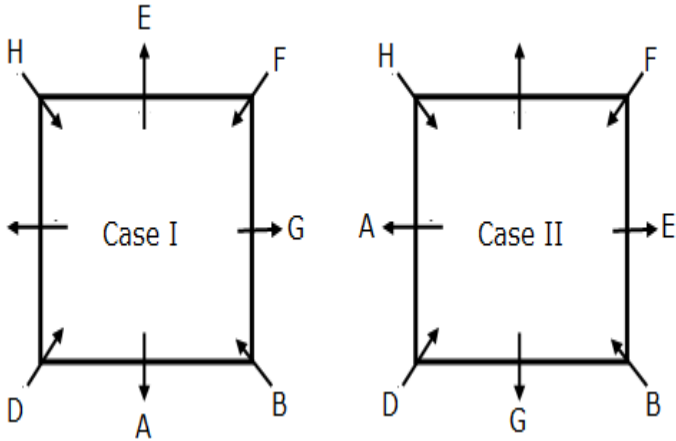

The number of persons sits between A and C is one more than the number of persons sits between F and G when counted from the left of both A and G.

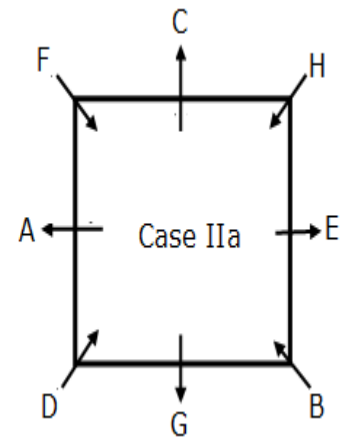
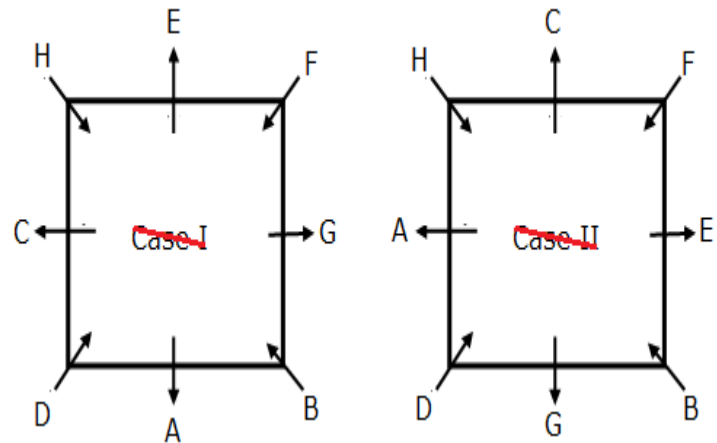

Directions (16-20):

- 16) Answer: C
- 17) Answer: E
- 18) Answer: B
- 19) Answer: C
- 20) Answer: E

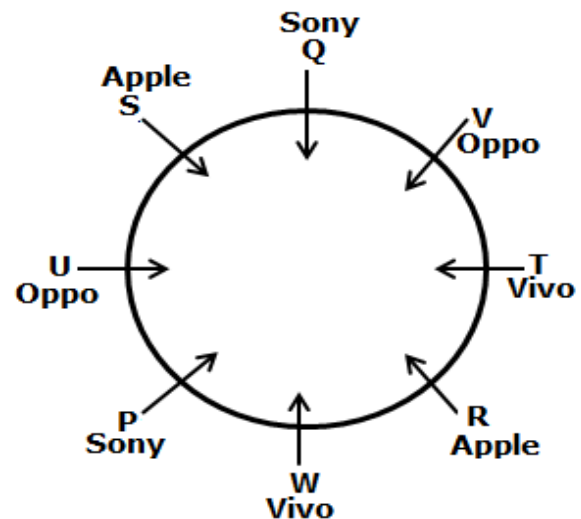

Top Important Seating Arrangement Questions for IBPS PO Pre 2021 – English Version

We again have,

- The person who uses Vivo is sitting second to the right of W, both of them using the same mobile brand.
- Two persons sit between W and the person who uses Oppo.

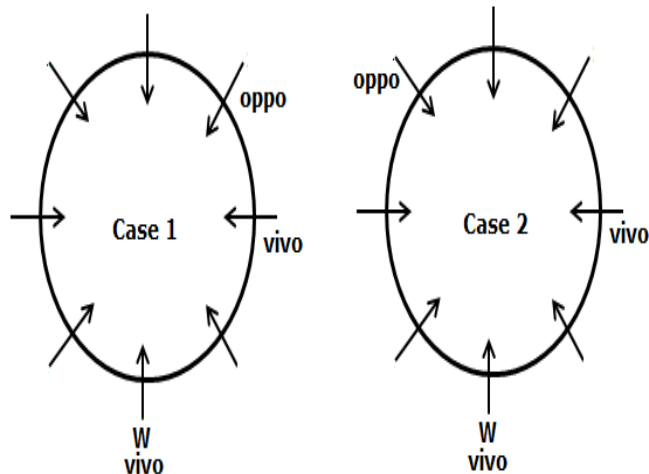

Again we have,

- Q uses Sony and sits opposite to W.
- Three persons sit between the persons who are using apple.
- One of the persons who uses apple has both the immediate neighbors are using Vivo.

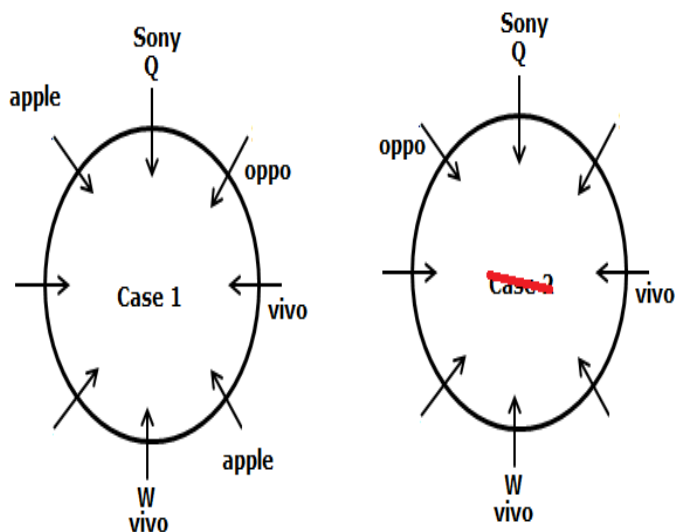

Again we have,

- U sits third to the left of R and using Oppo.

- V is not facing the person who uses Oppo and Apple.
- P is using the same mobile brand of Q and not an immediate neighbor of the person who uses Apple.
- S is not using Vivo.

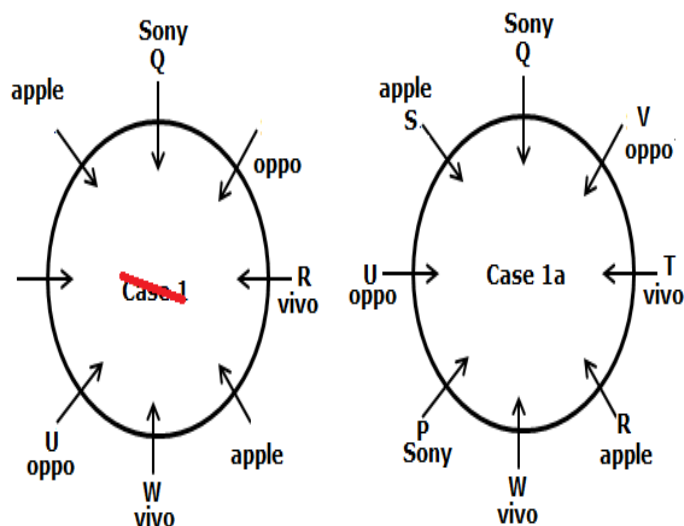

Directions (21-25):

- 21) Answer: D
- 22) Answer: A
- 23) Answer: B
- 24) Answer: B
- 25) Answer: C

Final Arrangement

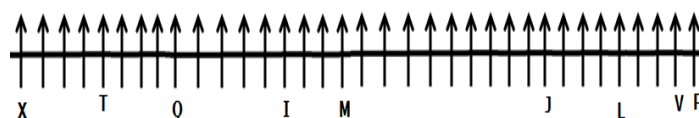

We have,

- Q sits fifth to the left of I.
- Only two persons are sitting between I and M.

From the above condition, there are two possibilities.

Top Important Seating Arrangement Questions for IBPS PO Pre 2021 – English Version

Case1

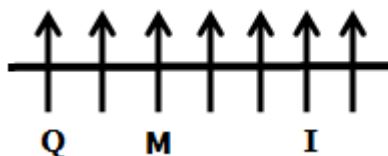

Case2

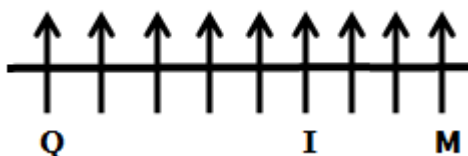

Again we have,

- The number of persons sitting between Q and M is two less than the number of persons sitting between M and J.
- I and J are not immediate neighbors.

From the above condition, there are three possibilities.

Case1

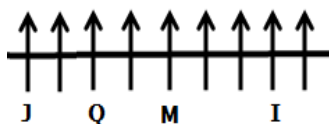

Case2

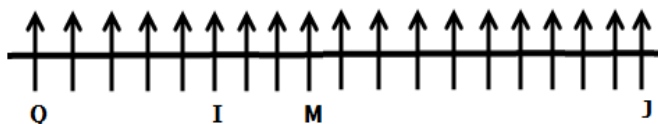

Case2a

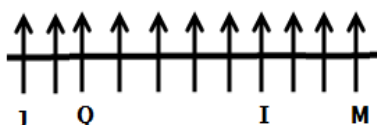

Again we have,

- L sits fourth to the right of J.
- X sits eighth to the left of Q.
- T sits exactly in the middle of Q and X who sits on one of the ends.

From the above condition, case1 gets eliminated.

~~Case1~~

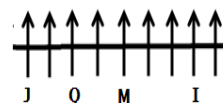

Case2

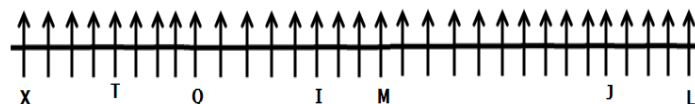

Case2a

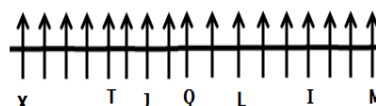

Again we have,

- The number of persons sits to the left of T is the same as the persons sits to the right of L.
- P sits immediate right of V.
- V sits to the right of J.
- P neither adjacent to I nor M.
- More than five persons sit between J and V.

From the above condition, case2a gets eliminated. Case2 shows the final arrangement.

Case2

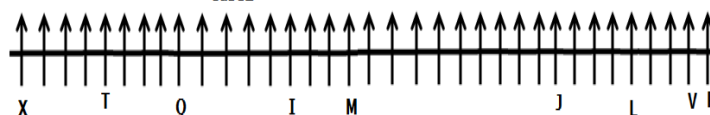

~~Case2a~~

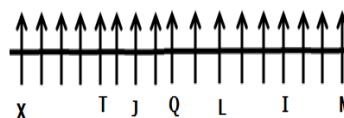

Direction (26-30):

- 26) Answer: A
- 27) Answer: B
- 28) Answer: A
- 29) Answer: D
- 30) Answer: C

Top Important Seating Arrangement Questions for IBPS PO Pre 2021 – English Version

From the given statements, there are three students sit between L and class 5 student. Here, we get two possibilities i.e. Case 1 and Case 2. Class 5 student sits immediate left of P. Q sits 3rd to the left of L. Class 7 student is an immediate neighbour of Q. Class 6 student sits 2nd to the right of class 7 student.

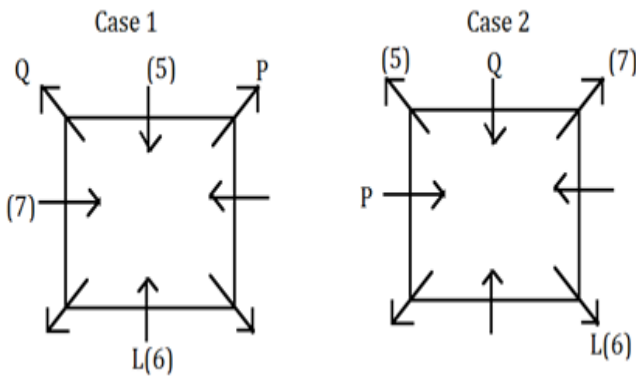

From the given statements, R who is in class 8, sits 3rd to the right of Q. S sits immediate right of J who is in class 9. Students of class 11 and 12 sit opposite to each other. Student of class 10 sits 2nd to the right of class 11 student. K who faces outside is not an immediate neighbor of Q. Here, Case 2 is ruled out.

So, final arrangement will be: -

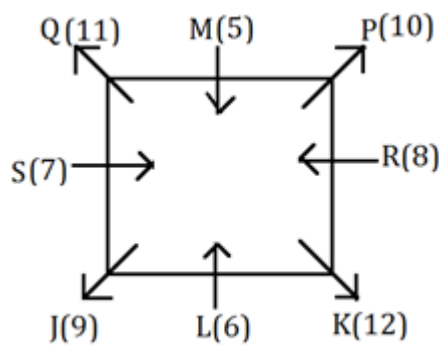

Directions (31-35):

- 31) Answer: D
- 32) Answer: E
- 33) Answer: E

34) Answer: C

35) Answer: D

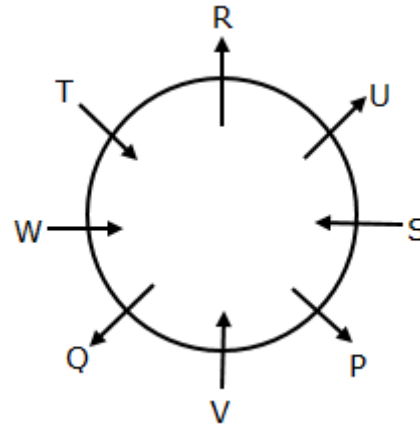

Three persons sit between V and R. Both R and V are facing the opposite directions to each other.

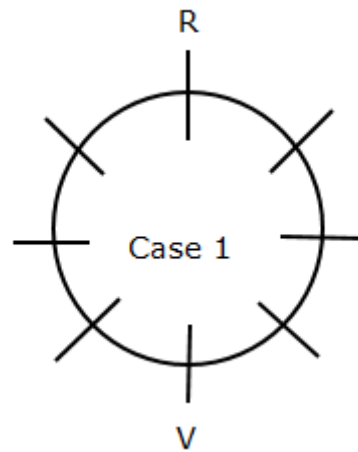

S sits second to the right of R. W faces the one who sits second to the right of V.

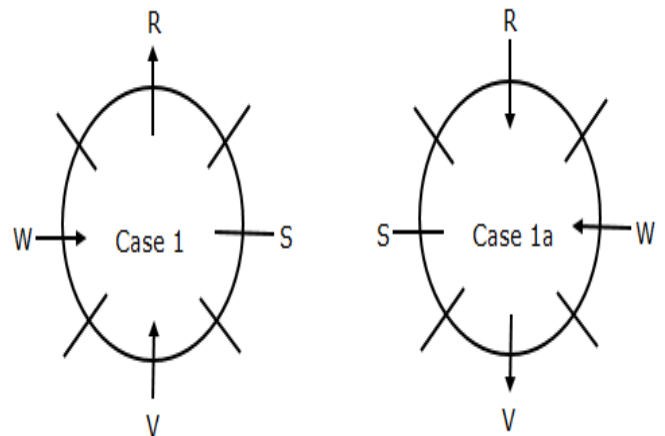

Top Important Seating Arrangement Questions for IBPS PO Pre 2021 – English Version

U sits third to the left of W. Neither R nor S sits an immediate neighbour of Q.

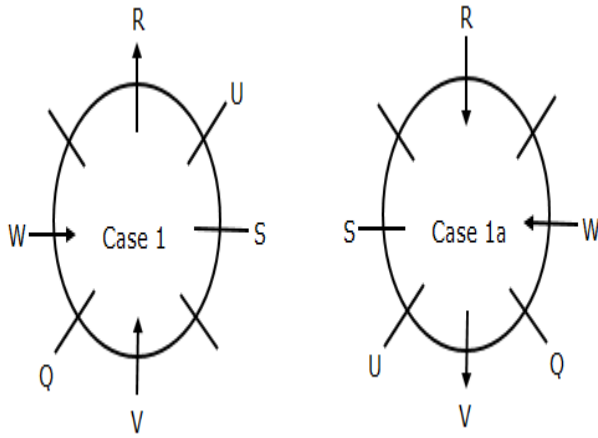

T faces the one who sits second to the left of Q. P facing outwards and the immediate neighbours of P facing the opposite direction to P.

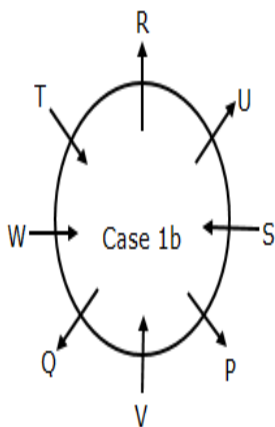
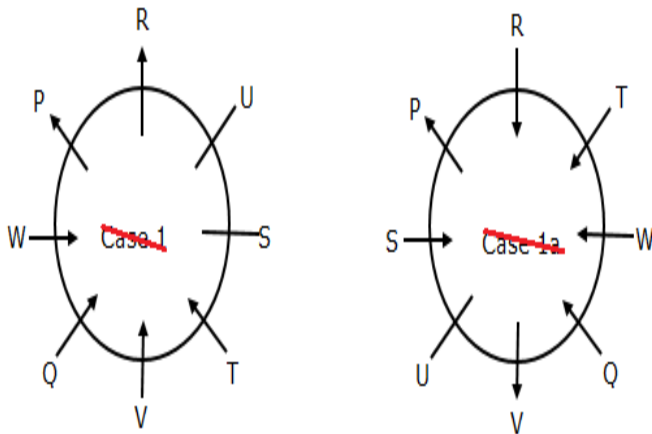

Case 1 gets eliminated because P facing outwards and the immediate neighbours of P

facing the opposite direction to P. case 1a doesn't follow the condition " Four of them are facing towards the table and four of them are facing outwards the table".

The final arrangement is,

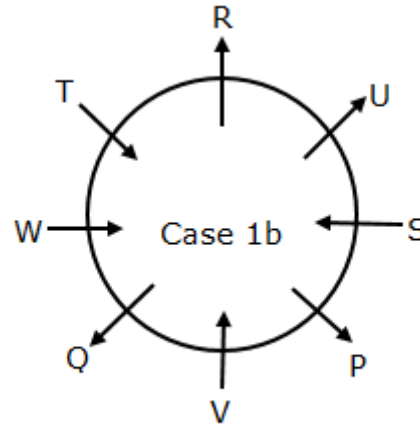

Directions (36-40):

- 36) Answer: A
- 37) Answer: C
- 38) Answer: C
- 39) Answer: E
- 40) Answer: A

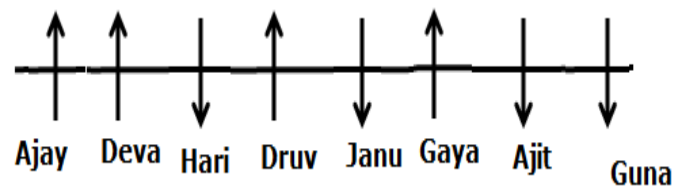

We have,

- Ajit sits third to the right of Druv, Vice versa.
- Only one person sits between Druv and Deva.
- Ajit and Deva are not immediate neighbors.

From the above condition, there are two possibilities.

Top Important Seating Arrangement Questions for IBPS PO Pre 2021 – English Version

Case1

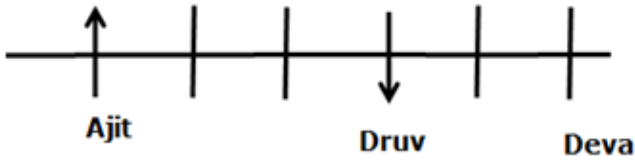

Case2

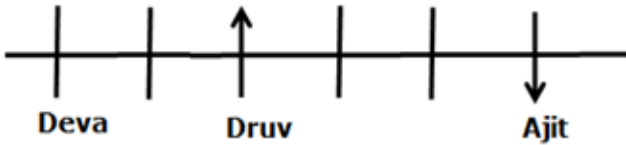

Again we have,

- Ajay sits adjacent to Deva and at sits end of the row.
- Hari sits second to the right of Ajay, vice versa.
- The persons who are sitting at the end are facing the opposite direction.

Case1

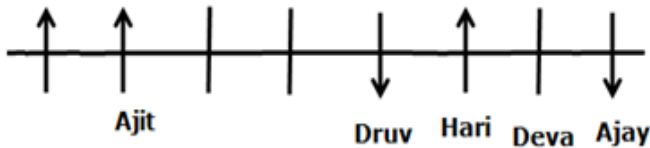

Case2

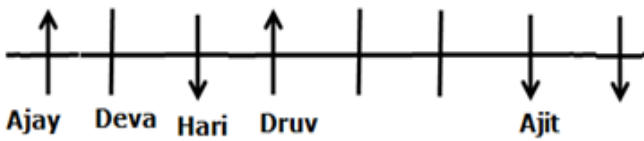

Again we have,

- The number of persons sitting between Gaya and Guna is the same as between Deva and Druv.
- Guna does not face the north direction.

Case1

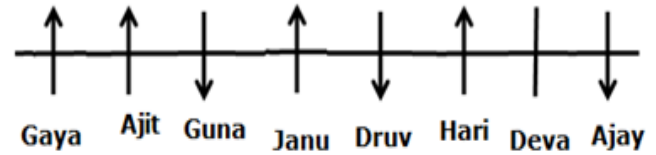

Case2

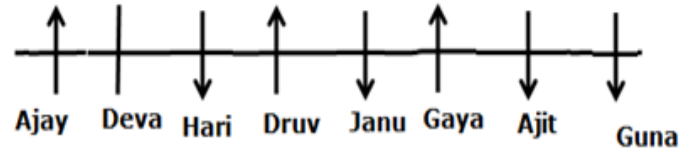

Again we have,

- Deva is facing the opposite direction of Guna.
- Immediate neighbor of Hari facing the same direction.

From the above condition, case1 gets eliminated. case2 shows the final arrangement.

~~Case1~~

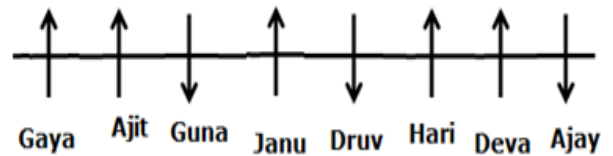

Case2

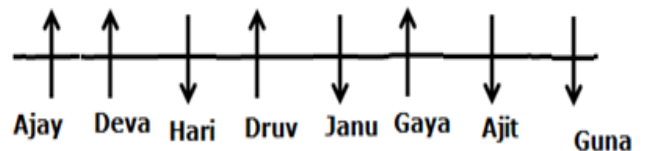

Directions (41-45):

- 41) Answer: C
- 42) Answer: E
- 43) Answer: B
- 44) Answer: D
- 45) Answer: E

Top Important Seating Arrangement Questions for IBPS PO Pre 2021 – English Version

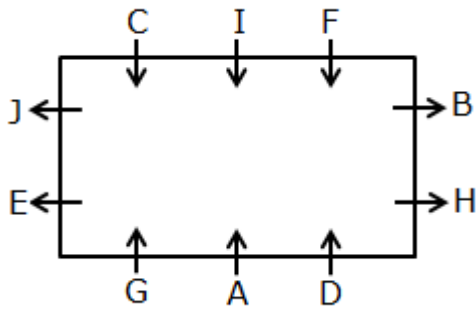

1. E sits to the immediate left of G and vice versa. H sits third to the right of G and immediate right of D.

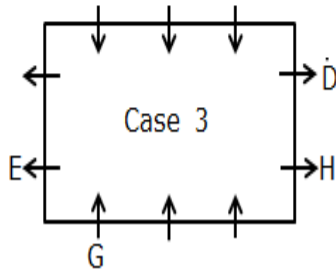
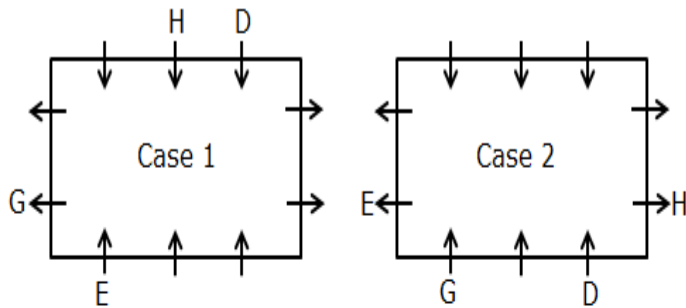

2. I sits to the immediate left of the one who is exactly opposite to G and is two persons away from B who is not the immediate neighbor of E. Hence, case 3 gets eliminated.

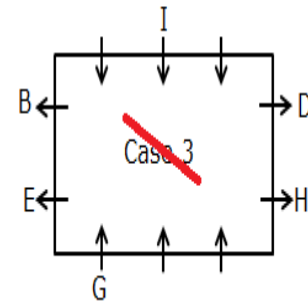
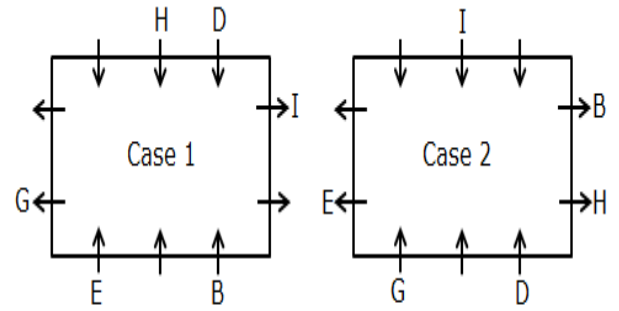

3. Both J and C sit adjacent to each other but don't face the same direction. A sits three persons away from J. F is neither adjacent to D nor opposite to G. Hence, case 1 gets eliminated.

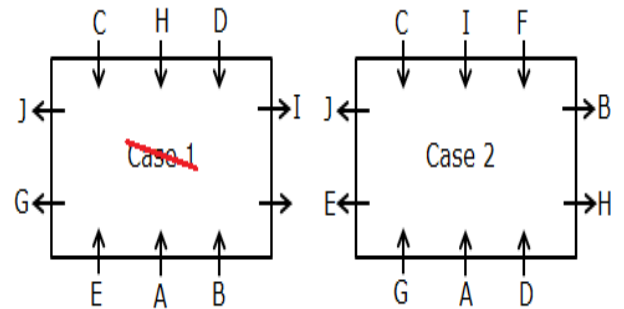

Directions (46-50):

- 46) Answer: C
- 47) Answer: E
- 48) Answer: D
- 49) Answer: C
- 50) Answer: D

Top Important Seating Arrangement Questions for IBPS PO Pre 2021 – English Version

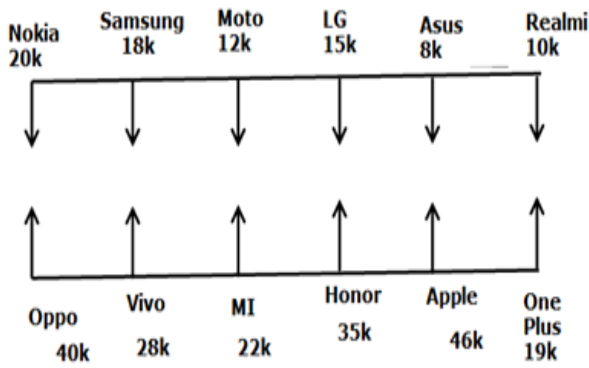

The price of Samsung is 18k which is placed 3rd to the right of the Asus which price is 8k which is second from the left end.

Asus is placed opposite to apple which is placed adjacent to Honor.

From the above condition, there are two possibilities.

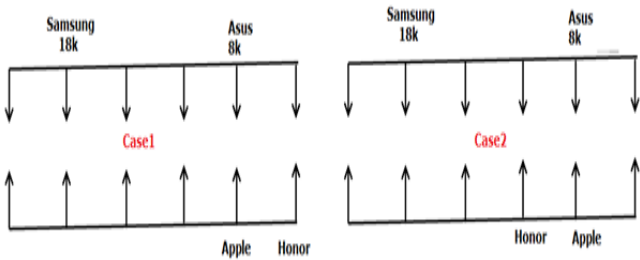

Only one mobile is placed between Honor & Vivo which is the immediate right of Oppo which is 40k.

The price of One plus is 19k diagonally opposite to Nokia which price is 20k. One plus is not adjacent to Honor.

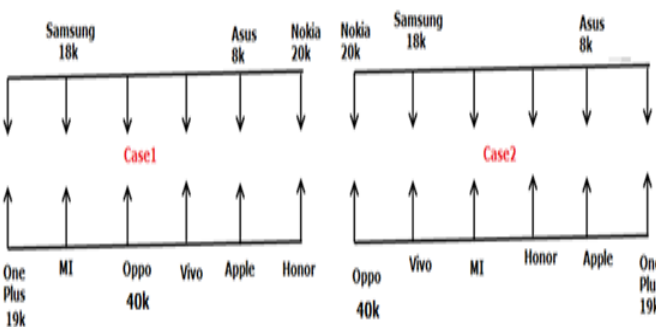

Moto placed opposite to 22k mobile.

Realme placed at one of the ends.

Realme is 2k less than moto which is 10k less than Mi. From this statement we know that the price of MI is 22k, Moto is 12k and Realme is 10k.

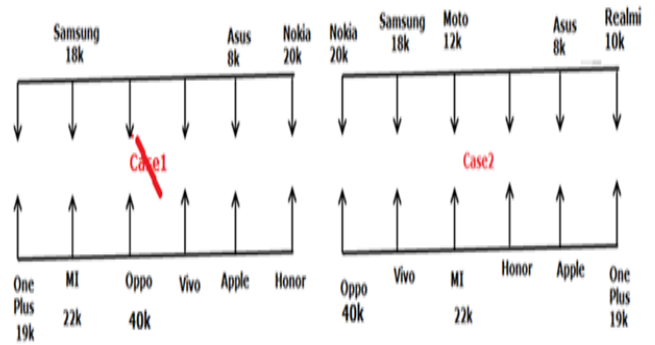

Two mobiles between 28k and 46k which are adjacent to 35k

From the above condition, Case 2 shows the final arrangement.

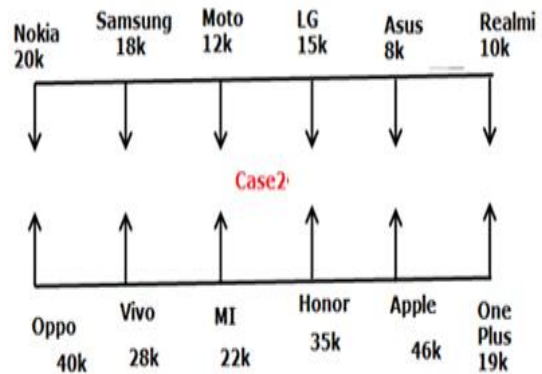

Grand Bundle PDF Course 2021

Exams Covered:

**SBI Clerk | SBI PO | IBPS RRB PO |
IBPS RRB Clerk | IBPS PO | IBPS Clerk**

Separate PDF Course for All Major Bank pre + Mains Exams

- Total No. of Ques: **40,000+**
- Question in Bilingual (Eng & Hindi)
- Answers With Detailed **Video Solution**
- Provides you **50 days Study Planner** for each exams
- **Covers All Types** of Questions in Each Topic
- Questions in **Exact Exam Level**
- All Our PDFs are **Downloadable**
- **100% Satisfaction** Assured & It's Worthy for your money
- Download as PDF & also take **Quiz with Timer**



Grab It Now

guidely

Grand Bundle PDF Course for All Bank Prelims Exams 2021

Separate PDF Courses for All Major Bank Exams

- Total Number of Questions: **25000**
- Language: English & Hindi
- Exact Exam Level Questions
- Answer Key with Video Solution

Exams Covered:

- SBI Clerk
- SBI PO
- IBPS PO
- IBPS Clerk
- IBPS RRB PO
- IBPS RRB Clerk

Validity: **1 Year**

Grab It Now

guidely

Grand Bundle PDF Course for All Bank Mains Exams 2021

Separate PDF Courses for All Major Bank Exams

- Total Number of Questions: **15000**
- Language: English & Hindi
- Exact Exam Level Questions
- Answer Key with Video Solution

Exams Covered:

- SBI Clerk
- SBI PO
- IBPS PO
- IBPS Clerk
- IBPS RRB PO
- IBPS RRB Clerk

Validity: **1 Year**

Grab it Now

guidely

Grand Bundle PDF Course Combo Prelims + Mains 2021

Separate PDF Courses for All Major Bank Exams

- Total Number of Questions: **40000+**
- Language: **English & Hindi**
- **Exact Exam Level Questions**
- Answer Key with **Video Solution**

Exams Covered:

- SBI Clerk
- SBI PO
- IBPS PO
- IBPS Clerk
- IBPS RRB PO
- IBPS RRB Clerk

Validity: **1 Year**

Grab it Now